

S V E N S K T T E N N

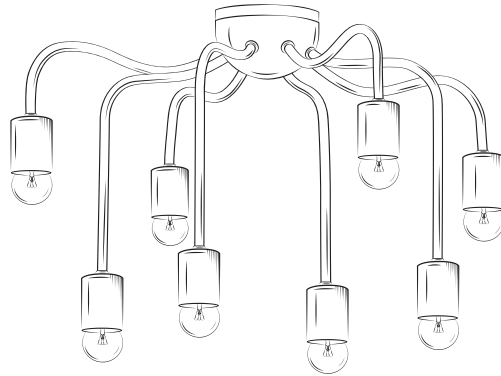

TAKLAMPAN 2358 | CEILING LAMP 2358

DESIGN: JOSEF FRANK, 1920-TAL (1920s)

SVENSKA ANVISNINGAR

Skruva fast träringen (D) och metallplattan (C) i taket. Trä kåpan (A) över metallplattan och reglera de två metallpinnarna i skårorna. Vrid och lås därefter med stoppskruven (E).

ENGLISH INSTRUCTIONS

Fasten the wooden ring (D) and metal plate (C) to the ceiling. Place the housing (A) over the metal plate and adjust the two metal pins in the grooves. Turn and lock with the set screw (E).

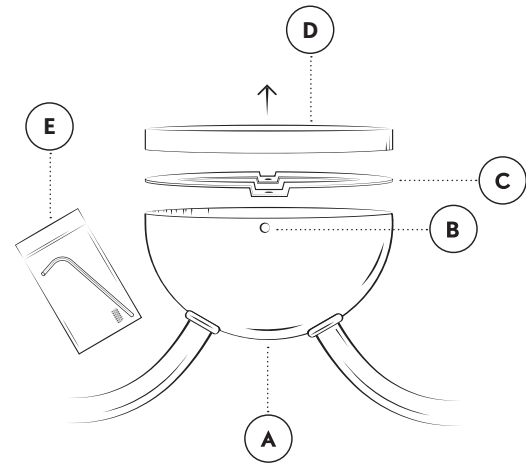

SVENSKA

- (A) Kåpa
- (B) Skruvhål
- (C) Metallplatta
- (D) Träring
- (E) Insexnyckel & stoppskruv

ENGLISH

- (A) Housing
- (B) Screwhole
- (C) Metal ceiling plate
- (D) Wooden ring
- (E) Allen key & set screw

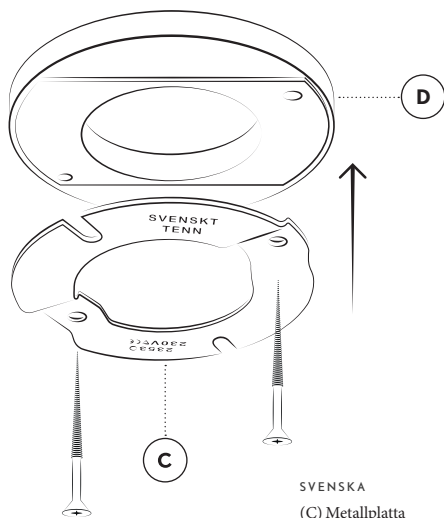

SVENSKA
 (C) Metallplatta
 (D) Träring

ENGLISH
 (C) Metal ceiling plate
 (D) Wooden ring

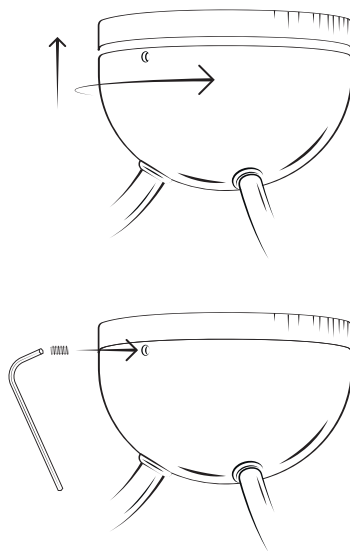

SVENSKA
 (A) Käpa
 (E) Insexnyckel & stoppskruv

ENGLISH
 (A) Housing
 (E) Allen key & set screw